

ALUMINUM SIDING AND TRIMS

ENDURING PERFORMANCE

Unsurpassed Quality Aluminum

- "Two-Coat" system includes a thermo-setting acrylic primer that is roller-coated, followed by a thermo-setting polyester (Polycoat 9000™) outside coating that is also roller-coated and baked over the primer. The "Two-Coat" system delivers an extremely durable and fade-resistant paint finish guaranteed not to flake or crack.
- Dark, rich decorative colors and complementary trims provide exceptional beauty that lasts.
- In-house aluminum coil coating ensures the best quality control.
- Complete color-coordinated range of accessories for limitless design possibilities.
- Chrome-free processes, water-conservation practices and waste minimization means full environmental responsibility far in advance of industry standards.

Aluminum Commercial Siding

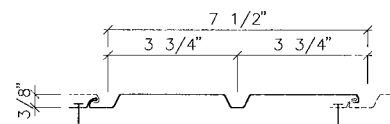
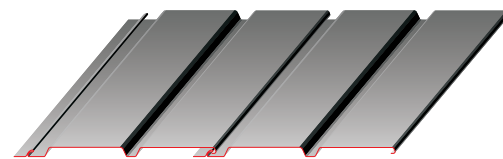

V-Groove

Aluminum Trim Coils



Aluminum Shutters



KAYCAN

All Kaycan aluminum sidings and accessories are backed by a lifetime limited warranty.



Enduring Performance



Aluminum Siding

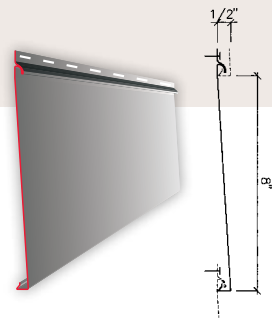

Smooth Horizontal 8"

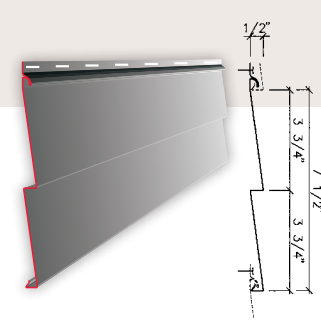

Smooth Horizontal D-4-75

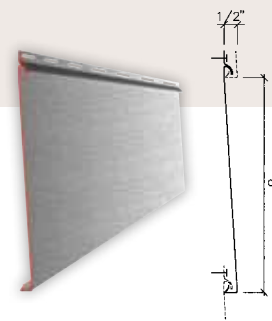

Driftwood Horizontal 8"

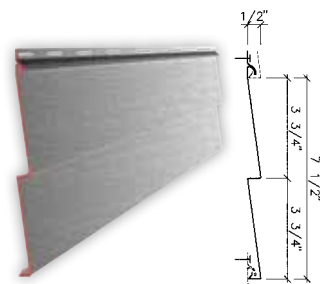

Driftwood Horizontal D-4-75

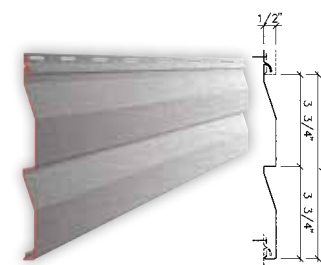

Futura D-4-75

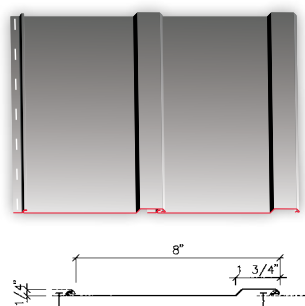

Smooth Vertical 8"

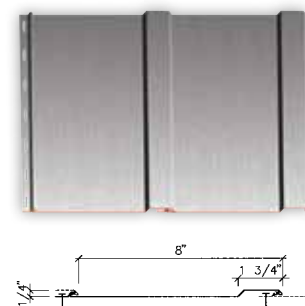

Driftwood Vertical 8"

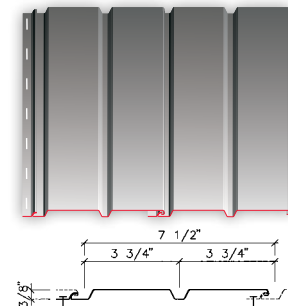

V-Groove Smooth Vertical

Aluminum Siding Accessories

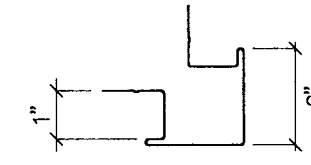

Outside Corner Post



Starter Strip

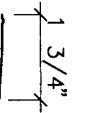
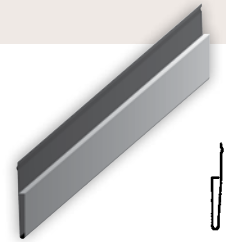

Sill Trim

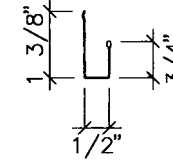
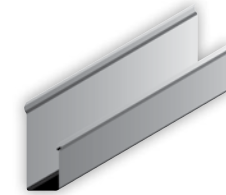

J Channel 1/2"

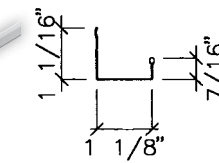

J Channel 1 1/8"

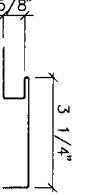
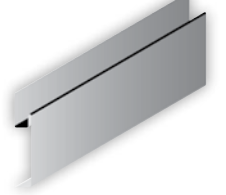

Aluminum Super J

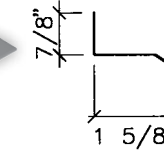
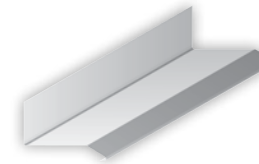

Drip Cap

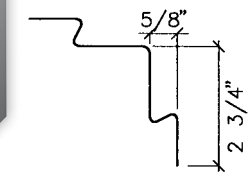
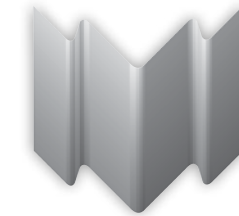

Base Corner Vinyl

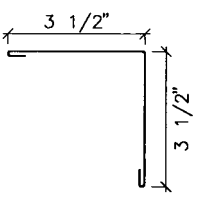

Corner Cap

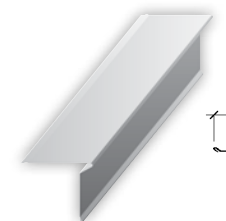

U.S. Drip Edge 2" Smooth

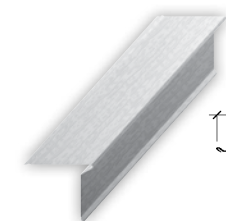

U.S. Drip Edge 2" Cedar Embossed



U.S. Drip Edge 2 1/2" Smooth

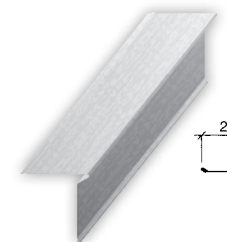

U.S. Drip Edge 2 1/2" Cedar Embossed

Kaycan's Aluminum Siding and Trims have long been the established standard within the industry, with a proven track record of over four decades for sturdiness, performance and beauty.

All of **Kaycan's** aluminum products are coated using a proprietary two-coat system and an advanced **Polycoat 9000™** topcoat, followed by a baked-on processing for an extremely durable and fade-resistant paint finish. **Kaycan's** coating has the lowest abrasive characteristic in the industry.

Kaycan's Aluminum Siding is available with both a textured or smooth finish. A complete range of color-coordinated trims and accessories are available. In addition, **Kaycan** offers the widest range of Trim Coils manufactured with the same proprietary technology for the best quality and selection.

Kaycan has taken full environmental responsibility far in advance of the industry with chrome-free processes, water-conservation practices and waste minimization through recycle and re-use programs.